



**KDB**  
Kinetic  
Doorbell Receiver

**KBP**  
Kinetic  
Bell Push Button

Installation Instructions

**Product Description:**

The Kinetic doorbell adopts wireless kinetic micro-energy collection and self-powered technology. The KBP bell push button requires no battery and is maintenance-free.



**KBP Bell Push button**      **KDB Doorbell receiver**

The KDB receiver is compatible with KBP bell push button and the KPIR Quinetic PIR. The KBP and KDB doorbells are not compatible with other Quinetic switches and controlling receivers.

**Specifications:**

- Operating Voltage: AC220V-240V 50/60Hz
- Power Supply: Self-Powered
- Communication: RF 433MHz
- Modulation: FSK
- Working Range: 80m\* (outdoor) / 30m\* (indoor)
- Volume Level: 4 levels
- Ringtones: 38 songs
- Temperature Range: Push button (-25°C~+55°C)  
Doorbell Receiver (-10°C~ + 55°C)
- Storage Capacity:
  - The receiver can be paired with up to 10 bell push buttons
  - One push button can be paired with an unlimited number of receivers

\*Distance comes from Kinetic laboratory test result. The actual distance in practical use might vary due to environmental difference.

**Installation:**

1. Plug the doorbell receiver directly into the electrical socket and it will ring once after the power is on. This product is suitable for indoors use only. Please avoid using it in high temperature, high humidity, dusty, and strong electromagnetic interference environments. (It is recommended to install it above 50cm from the ground, otherwise the signal will be weakened.)

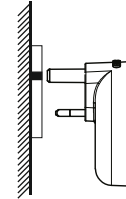

2. Use screws to install the KBP fixing part. Tear off the 3M sticker on the back of the bell push and then paste it on the fixing part. (Do not stick on a metal door, otherwise it will affect the signal.)

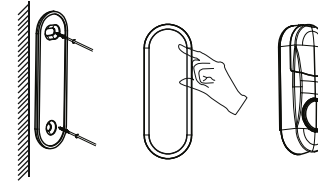

**Doorbell Receiver Key Description:**

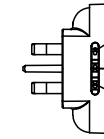

- **Volume key:** Pres this key and the volume will switch between levels 1-4.
- **Ringtone selection key +:** Press this key to cycle through the available ringtones.
- **Ringtone selection key -/Pairing button:** Used for pairing and changing the ringtone to the previous one.

**Pairing Method:**

1. For **single or multiple bell push buttons** pairing or if the bell push needs to be paired with the doorbell receiver again follow the steps below:

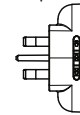

- Press the **ringtone selection key -** for 3 seconds until the light is flashing, then release the button.
- Press the bell push once and the light will go off. This means that the pairing is successful.



(If **multiple doorbell receivers** or bell pushes need to be paired repeat the above steps.)



- KPIR pairing instructions:**  
Follow a. above then press and hold the pairing button on the **PIR sensor** for 3 seconds and the green LED sensor indicator will start flash slowly. Release the button and the PIR sensor enters pairing mode. Press the pairing button on the PIR sensor once, and the indicator on the doorbell receiver will stop flashing. This means that the pairing is successful.

- For **multiple bell push buttons** pairing with a single doorbell using **multiple ringtones** follow the steps below:
  - Press the **ringtone selection key +** first and choose the desired ringtone.
  - Press the **ringtone selection key -** for 3 seconds until the light is flashing, then release the button.
  - Press the corresponding bell push once and the light will go off. This means that the pairing is successful.
  - Use the above steps for pairing with other bell push buttons.

**Doorbell Receiver Clear Pairing:**

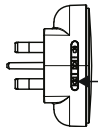

Press the **ringtone selection key -** for 12 seconds until the light changes from flashing to still to off. The button can then be released. Once done all pairing information is cleared down.

**Power cut memory**

After a power cut the doorbell memorises the last set ringtone and ring volume.

**Night Light Mode**

The KDB Quinetic doorbell receiver can be used as a night light. Once the doorbell receiver is installed in place and it is set to night light it will not work as a doorbell anymore. The bell push will act as a wireless switch and can be installed near the bed or in other convenient locations.

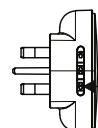

- Press the **ringtone selection key -** for 6 seconds until the light changes from flashing to still and then release the button. The night light mode is on.
- To turn off the night light mode to restore the doorbell function press the **music selection key -** for 6 seconds, then release the button when the light is still.

**KDB - Product dimensions:**

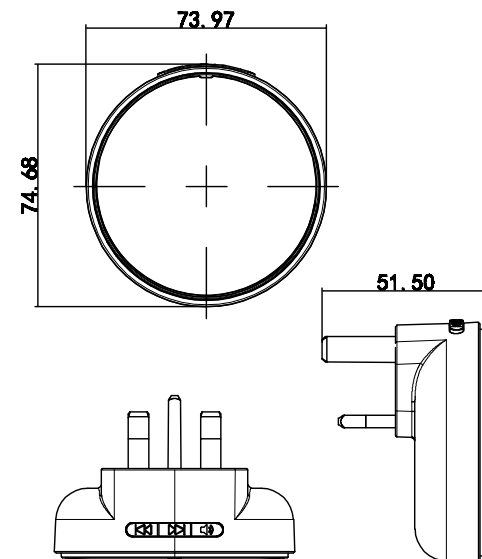

**KBP - Product dimensions:**

